

# Comprehensive Total Shoulder System

Featuring Comprehensive Access Glenoid Instrumentation

Surgical Technique





# Table of Contents

<b>Patient Positioning and Surgical Incision</b> .....	5
<b>Humeral Stem Technique</b> .....	7
Humeral Preparation	
Intramedullary Resection Guide	
Humeral Broaching	
Calcar Planer	
Humeral Stem Insertion - Press Fit Technique	
Humeral Stem Insertion - Cemented Technique	
<b>Versa-Dial Humeral Head Technique</b> .....	17
Head Selection and Head Offset	
Head Assembly	
Head Insertion	
<b>Access Cannulated Glenoid Technique</b> .....	20
Sizer Pin Guides	
Glenoid Vault Pin Guide	
Glenoid Reaming/Central Post Preparation	
Peripheral Peg Preparation	
Optional Poly Post Preparation	
<b>Non-cannulated Glenoid Technique</b> .....	25
Sizing and Reaming	
Peripheral Peg Drilling	
Regenerex Porous Titanium or Polyethylene Central Peg	
Trial Reduction	
Glenoid Fixation	
<b>Keeled Glenoid Technique</b> .....	29
Sizing and Reaming	
Drilling	
Glenoid Fixation	
Postoperative Care	
<b>Hybrid Glenoid Technique</b> .....	32
Polyethylene Preparation	
Polyethylene Removal	
Central Post Removal	
<b>Appendix</b> .....	37
<b>Ordering Information</b> .....	38

## INDICATIONS

1. Non-inflammatory degenerative joint disease including osteoarthritis and avascular necrosis.
2. Rheumatoid arthritis.
3. Revision where other devices or treatments have failed.
4. Correction of functional deformity.
5. Fractures of the proximal humerus, where other methods of treatment are deemed inadequate.
6. Difficult clinical management problems, including cuff arthropathy, where other methods of treatment may not be suitable or may be inadequate.

Humeral components with a MacroBond surface coating are indicated for either cemented or uncemented press-fit applications.

Humeral/glenoid components with a porous coated surface coating are indicated for either cemented or uncemented biological fixation applications. (Metal backed glenoid components offer optional screw fixation).

Glenoid components with Hydroxyapatite (HA) coating applied over the porous coating are indicated only for uncemented biological fixation applications. (Metal backed glenoid components offer optional screw fixation).

Humeral components with a non-coated (Interlok) surface are indicated for cemented application only.

Polyethylene glenoid components not attached to a metal back are indicated for cemented application only.

The Comprehensive Modular Hybrid Glenoid is intended to be implanted with bone cement. The optional porous titanium peg may be inserted without bone cement. The optional polyethylene peg should be inserted with bone cement.

The Comprehensive Humeral Positioning Sleeves are for cemented use only and are intended for use with the Comprehensive Fracture Stem.

The Comprehensive Shoulder Stems (Fracture, Primary and Revision) are intended for use with the Bio-Modular Humeral Heads and glenoid components and Versa-Dial Humeral Heads.

The Versa-Dial Humeral Head Prosthesis is intended for use only with the Comprehensive Shoulder Stems (Fracture, Primary and Revision), the Bio-Modular Shoulder Stems and the glenoid components of the Bio-Modular Shoulder System.

In addition to those specified above, the Proximal Shoulder Replacement prostheses are indicated for use in oncology applications, complex humeral fractures and revisions.

The Titanium Versa-Dial Humeral Head Prosthesis are indicated for patients with suspected cobalt alloy sensitivity. The wear properties of Titanium and Titanium alloys are inferior to that of cobalt alloy. A Titanium humeral head is not recommended for patients who lack suspected material sensitivity to cobalt alloy.\*

\*The Titanium Versa-Dial Humeral Head Prosthesis is not for sale in Canada

This brochure is presented to demonstrate the Comprehensive Access Glenoid Instrumentation surgical technique utilized by John Sperling, M.D.; Professor Simon Frostick; Jason Hurst, M.D.; Thomas Throckmorton, M.D.

This brochure is presented to demonstrate the Comprehensive Total Shoulder System surgical technique utilized by John Sperling, M.D.; David Dines, M.D.; Russell Warren, M.D.; Edward Craig, M.D.; Donald Lee, M.D.; and Timothy Codd, M.D. Biomet, as a manufacturer of this device, does not practice medicine and does not recommend this device or technique. Each surgeon is responsible for determining the appropriate device and technique to utilize on each individual patient.

## Patient Positioning and Incision



Figure 1



Figure 2

### Surgical Position

The arm and shoulder are prepped and draped free (Figure 1). Utilize a modified beach chair position.

### Surgical Incision

Utilize an extended deltopectoral anterior incision with an optional biceps tenodesis beginning immediately above the coracoid process and extending distally and laterally, following the deltopectoral groove along the anterior border of the deltoid (Figure 2). Laterally retract the deltoid muscle, avoiding release of the deltoid from the clavicle. The deltoid may be partially released from its distal insertion by subperiosteal dissection. Make a partial relaxing incision through the proximal coracoid tendon and medially retract the conjoined tendon.

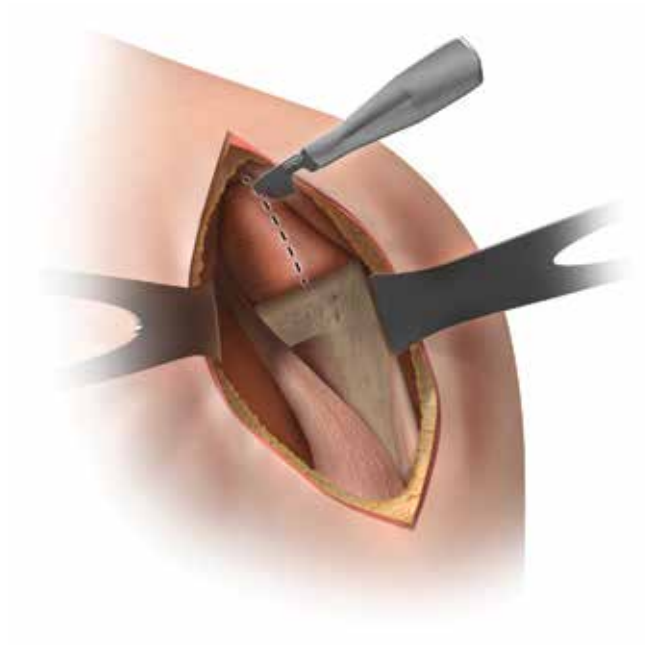

Figure 3

### Surgical Incision (cont.)

Identify anterior structures and externally rotate the humerus. Make a longitudinal incision through the tendinous portion of the subscapularis muscle and capsule, just medial to the lesser tuberosity (Figure 3). In cases of severe contracture, subscapularis lengthening may be required.

ⓘ **Note:** A lesser tuberosity osteotomy may also be performed in order to release the subscapularis.

Tag the subscapularis tendon with non-absorbent sutures. Externally rotate and extend the humerus to expose the humeral head, while protecting the axillary nerve.

## Standard, Mini, and Micro Stem Technique



Figure 4

Figure 5

Figure 6

### Humeral Preparation

Using the 4, 5 or 6 mm starter reamer and ratcheting T-handle, bore a pilot hole through the humeral head along the axis of the humeral shaft, just lateral to the head's articular surface and just medial to the rotator cuff attachment. Insert the humeral reamer to the depths described below for the chosen stem. Continue reaming in 1 mm increments until cortical contact is achieved. Note the reamer size for future reference.

**Standard Stem** – Using the standard length reamers, insert each reamer until the engraved line just above the cutting teeth is even with the greater tuberosity (Figure 4).

**Mini Stem** – Using the standard length reamers, insert each reamer until the large hashmark between the 3 and 4 on the reamer is even with the greater tuberosity (Figure 5).

**Micro Stem** – Using the Micro length reamers, insert each reamer until the engraved line just above the cutting teeth is even with the greater tuberosity (Figure 6).

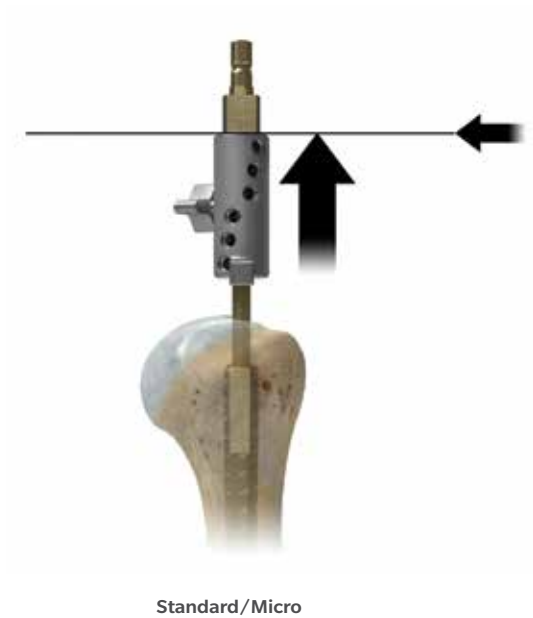

Figure 7

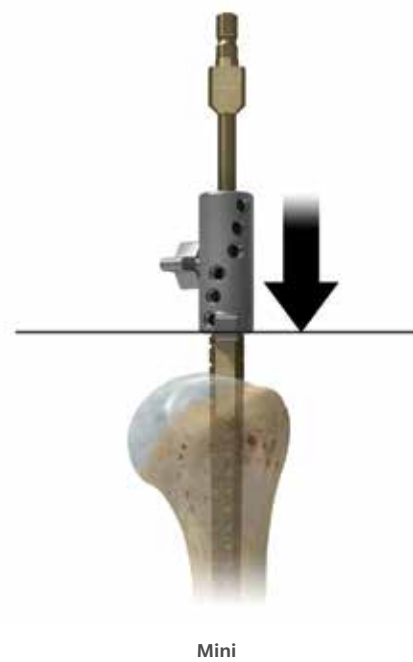

Figure 8

## Intramedullary Resection Guide

Place the resection guide boom onto the reamer shaft to the below described locations depending on stem selection.

**Note:** The position of the resection guide boom on the reamer shaft, along with the calibrated reaming depth and stem choice, are directly related to the proper resection height. However, the final resection height should be based off the location of the rotator cuff insertion (approximately 1 mm above the insertion). An ideal humeral resection is slightly above the rotator cuff insertion. This allows for greater glenoid exposure and easier conversion to a subsequent reverse shoulder arthroplasty should that be indicated.

**Standard Stem** – Place the resection guide boom on the reamer shaft and slide it up until it rests against the top of the reamer, just below the sizing engraving (Figure 7).

**Mini Stem** – Place the resection guide boom on the reamer shaft and slide it down until it rests against the base surface of the reamer, just above the cutting teeth (Figure 8).

**Micro Stem** – Place the resection guide boom on the reamer shaft and slide it up until it rests against the top of the reamer, just below the sizing engraving (Figure 7)

**Note:** The resection guide boom is NOT engraved with Micro.





Standard/Micro

Figure 9



Mini

Figure 10

## Intramedullary Resection Guide (cont.)

Place the IM resection guide block onto the arm of the boom in the proper orientation. For example, “right” should be visible for a right shoulder.

Standard and Micro Technique (Figure 9). Mini Technique (Figure 10).

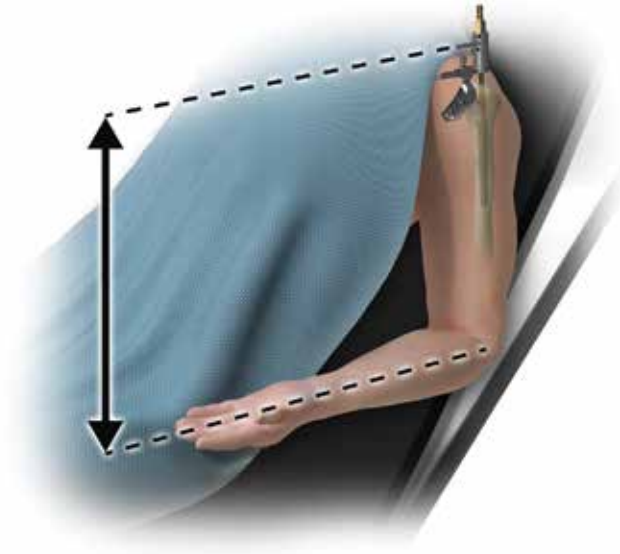

Figure 11

## Intramedullary Resection Guide (cont.)

Screw the version rod into the appropriate version hole, and align the rod with the forearm flexed at 90 degrees (Figure 11).

ⓘ **Note:** The thumb screw on the resection boom is not captured. Care should be taken when adjusting/tightening



Standard/Micro

Figure 12

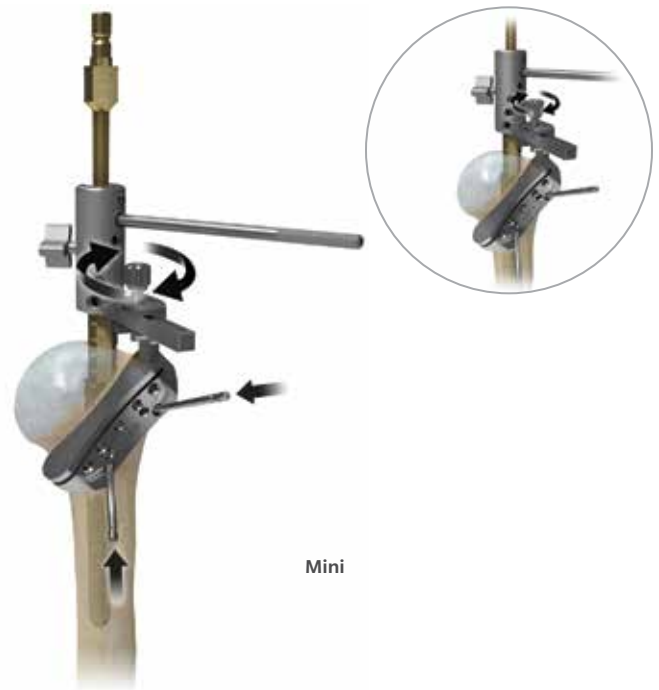

Mini

Figure 13

## Intramedullary Resection Guide (cont.)

Set the correct version using the amount of external rotation of the forearm, slide the resection guide against the humerus and finger tighten the thumb screw.

**Note:** The thumb screw on the resection boom is not captured. Care should be taken when adjusting/tightening.

Place two threaded Steinman pins through converging angled holes in the resection guide block and into the bone to secure the block to the bone. Standard and Micro Technique (Figure 12). Mini Technique (Figure 13).



Standard/Micro

Figure 14



Mini

Figure 15

## Intramedullary Resection Guide (cont.)

Completely loosen the thumb screw on the resection guide block and reamer shaft. Rotate the resection guide boom until the arm clears the resection block.

Standard and Micro Technique (Figure 14). Mini Technique (Figure 15). Remove the reamer and guide boom.



Figure 16



Figure 17



Figure 18

## Intramedullary Resection Guide (cont.)

Prior to making the humeral resection, the planned resection should be confirmed with the angel wing/tissue probe. Place a saw blade through the cutting slot in the guide. The saw blade should be moving when it comes in contact with the bone (Figure 16). Resect the humeral head. Remove the Steinmann pins and the cut block.

## Humeral Broaching

Select a broach that is at least 2 to 3 mm smaller than the last reamer used and attach it to the broach handle.

**Standard and Mini Stem** – Use Mini length broaches (Figure 17).

**Micro Stem** – Use Micro length broaches (Figure 18).



Figure 19



Figure 20

## Intramedullary Resection Guide (cont.)

Insert the version rod into the same position used during resection. Flex the forearm to 90 degrees, and externally rotate the arm to be parallel with the version control rod indicating the chosen amount of retroversion. Sequentially broach in 1 mm increments until the broach size is equal to the size of the humeral reamer. For example, if the etching on the last reamer used indicated 10 mm, broach up to 10 mm (Figure 19).

☰ **Tip:** Advance each broach into the humerus in several successive motions, tapping it up as well as down between advancements. The broach is fully seated when the collar on the broach handle rests on the resected surface of the humerus. Remove the broach handle, leaving the last broach in place to be used as a trial.

☰ **Caution:** If the broach feels too tight and will not seat, finish broaching with next smaller size.

☰ **Note:** The porous coating on the humeral stem is 0.75 mm thick on all sides (1.5 mm circumferentially), which will cause the final implant to fit tighter than the broach.

## Calcar Planer

Use the calcar planer to refine the resected surface. Attach the planer blade that most closely matches the diameter of the resected surface to the barrel of the calcar planer. Insert the planer plunger into the female taper of the broach. Begin rotation of the calcar planer before contacting the resected surface. Apply slight pressure and plane the resected surface (Figure 20).

☰ **Note:** The calcar planer should not be used in conjunction with the definitive implant. This could potentially damage the reverse Morse taper.

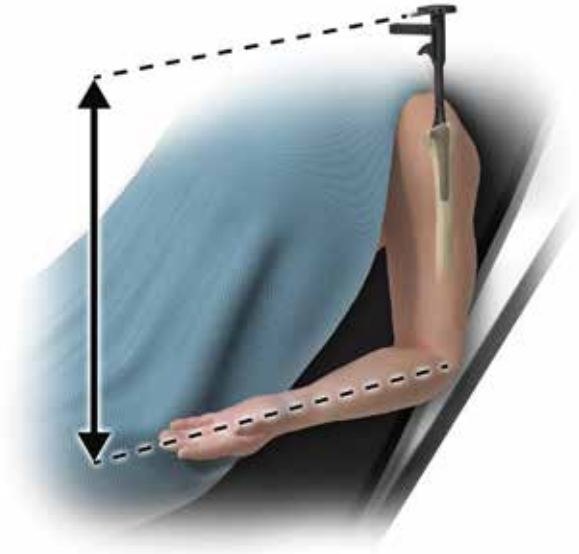

Figure 21



Figure 22

### Humeral Stem Insertion – Press-fit Technique

Attach the broach handle to the broach/trial, and remove it from the humeral canal. Select a humeral stem which matches the final broach/trial used. Assemble the humeral stem onto the humeral stem inserter. Place the version control rod into the appropriate version hole and align it with the forearm flexed at 90 degrees (Figure 21).

Insert the stem into the humeral canal (Figure 22) impacting if necessary.

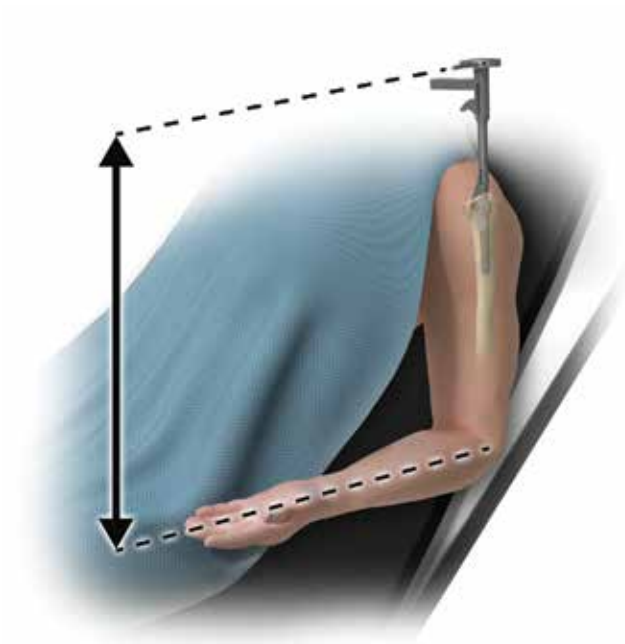

Figure 23



Figure 24

## Humeral Stem Insertion – Cemented Technique

Attach the broach handle to the broach/trial, and remove it from the humeral canal. Select a humeral stem 2 mm smaller than the final broach/trial used. Assemble the humeral stem onto the humeral stem inserter. Use a pulse lavage/suction unit to thoroughly clean the humeral canal. Dry the canal with absorbent gauze and inject doughy cement in a retrograde manner, completely filling the humeral canal. Place the version control rod into the appropriate version hole and align it with the forearm flexed at 90 degrees (Figure 23).

Introduce the implant into the humeral canal (Figure 24), keeping the alignment rod in line with the forearm, until the desired position is attained. Remove excess cement.



## Versa-Dial Head Technique

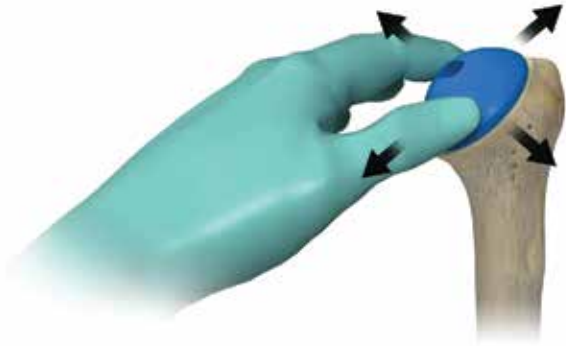

Figure 25



Figure 26

### Head Selection

Using the resected humeral head for comparison, select an appropriately sized head trial and assemble to a standard trial taper adaptor. Determine the amount of desired offset by maximizing the coverage of the Versa-Dial provisional over the resected surface of the humerus (Figure 25). After maximum coverage of the resected surface is achieved, tighten the taper adaptor trial in the head trial with a hex driver (Figure 26). Reduce the joint and perform a trial range of motion.

**Note:** The head trial will still rotate within the broach. The screw only locks in the desired amount of offset. It also may be advisable to mark the humerus with the offset direction in order to accurately replicate the exact position when it comes to implanting the definitive humeral head.

### Head Offset

Remove the Versa-Dial trial assembly from the humeral stem. Determine the amount of offset needed by

referencing the indications on the underside of the trial head and trial adaptor (Figure 26 inset), keeping in mind that the offset chosen may be between letters.



Figure 27



Figure 28

## Head Assembly

Place the Versa-Dial head into the impactor tray. Ensuring the components are clean and dry, insert the Versa-Dial taper adaptor into the head (Figure 27). Rotate the taper adaptor until the trial offset is replicated. For example, if trialing indicated halfway between the B and C hashmarks, the implant taper adaptor is aligned so its hashmark is halfway between the B and C on the head.

Engage the Morse taper with two firm strikes, using the taper impactor tool and mallet (Figure 28). The taper/head assembly is now securely fastened.



Figure 29

## Head Insertion

Clean and dry the reverse Morse taper with the taper swabs packaged with the stem. Gently place the Versa-Dial head onto the stem and rotate to achieve maximum coverage of the resected surface (Figure 29). This coverage should replicate the offset direction that was used while performing the trial reduction.

Impact the head onto the stem to complete humeral head implantation by using at least two blows with an appropriately sized surgical mallet and the head impactor tool.

## Access Cannulated Glenoid Technique

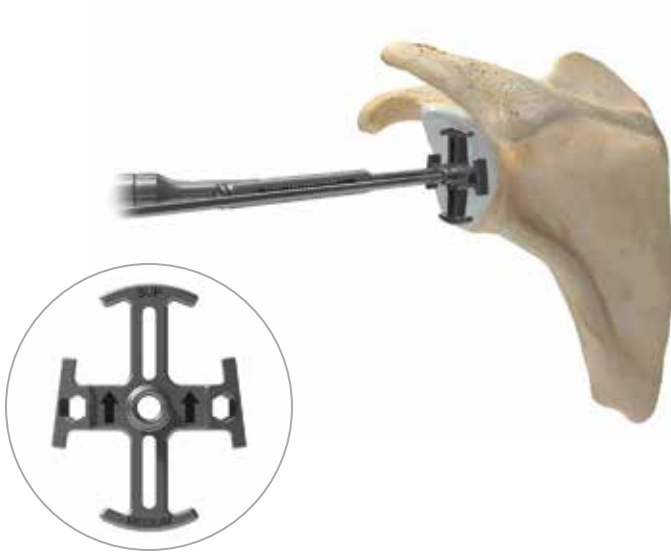

Figure 30

### Sizer Pin Guides

Based on the operative shoulder, attach the quick-connect guide handle to the appropriate Sizer Pin Guide (Figure 30). Place the sizer in the middle of the glenoid in the correct orientation. Slots in the guide are provided for visualization if the glenoid has been sectioned into quadrants by using a bovie.

Insert the 3.2 mm threaded Steinman pin through the sizer and carefully drill under power until the Steinman pin has engaged the medial cortex of the glenoid vault. Once the Steinman pin is securely placed, back the guide out over the pin and remove from the joint.



Figure 31

### Glenoid Vault Pin Guide

As an alternative method of placing the initial Steinman pin, the Glenoid Vault Pin Guide can be used to place the guide pin by referencing the junction of the anterior glenoid neck and the scapular body.

Attach the quick-connect guide handle to the Glenoid Vault Pin Guide. Prior to inserting into the joint, be sure that the screw is locked into place to prevent the guide hinge from moving. Insert the Glenoid Vault Pin Guide into the joint and proceed to slide the tip of the guide down the anterior wall of the glenoid until it reaches the lateral aspect of the subscapularis fossa. A finger can be used to assess the correct placement of the guide along the scapular body. Once desired placement is found, identify the pin hole that best locates the center of the glenoid and insert the 3.2 mm Glenoid Vault Pin Guide (Figure 31).



Figure 32

### Glenoid Vault Pin Guide (cont.)

ⓘ **Note:** This guide will help control version, however, careful attention should be made to the inclination of the pin. Each hole in the guide will direct the Steinman pin towards the tip of the guide.

Proceed carefully under power until the medial cortex is engaged with the threaded tip of the Steinman pin. Remove the drill from the pin, leaving the pin in place. Release the pin guide by unthreading the thumb screw and back the guide out over the pin and remove from the joint. The glenoid sizer can then be placed over the pin to determine appropriate glenoid size.

ⓘ **Note:** The Versa-Dial screw driver can be used to unthread the thumb screw if needed.

### Glenoid Reaming/Central Post Preparation

Choose the appropriate size Glenoid Face Reamer based off of the previous glenoid sizer. Assemble the chosen Glenoid Face Reamer with the modular handle. Insert the reamer into the joint over the pin. The glenoid should be reamed to the proper version and inclination as determined by the preoperative plan and intraoperative observation (Figure 32).

ⓘ **Caution:** As with any reaming, it is important to start the reamer rotating prior to coming into contact with bone. This will ensure that the reamer is rotating freely and clear of any soft tissues or other instruments that may be an obstruction.

ⓘ **Caution:** Over-reaming can decrease the surface area of the glenoid and the depth of the glenoid vault which can lead to insufficient seating or subsidence of the implant.

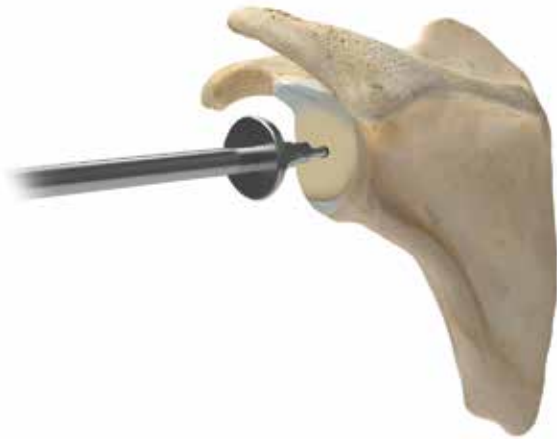

Figure 33

### Glenoid Reaming/Central Post Preparation (cont.)

Once the desired amount of reaming is completed, the 2-in-1 Central Post Cutter will be used to prepare for the central boss and Regenerex Central Post geometry. Insert the 2-in-1 central post cutter into the joint over the guide pin and proceed to ream until the stop is engaged against the newly reamed surface of the glenoid face (Figure 33).

**ⓘ Caution:** As with any reaming, it is important that the central post cutter is rotating prior to coming into contact with bone to avoid any undesirable outcomes.

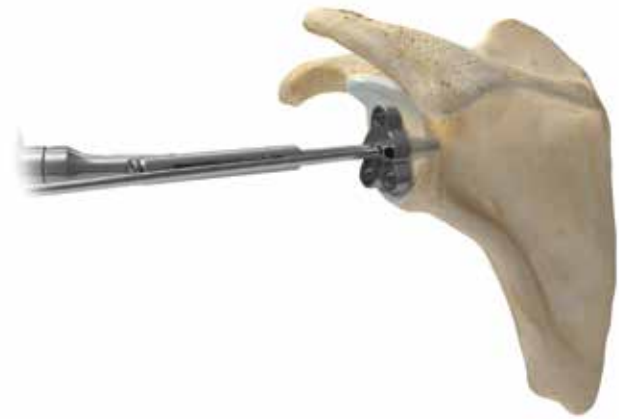

Figure 34

### Peripheral Peg Preparation

Select the appropriate size Cannulated Peripheral Peg Drill Guide and attach a quick-connect guide handle. Insert the guide over the Steinman Pin and into the joint until it is fully seated against the face of the glenoid (Figure 34).



Figure 35

### Peripheral Peg Preparation (cont.)

Insert a quick-release drill into the quick-release driver. Drill the superior hole until the stop is engaged. Remove the driver from the joint while leaving the drill bit in place to function as an anti-rotation peg. The drill bit is connected to the driver with a magnetic connection. Once drilled, the bone will provide enough friction to retain the drill bit as an anti-rotation peg.

ⓘ **Note:** Be sure that the drill driver has stopped rotating prior to disconnecting from the drill bit/anti-rotation peg.

Insert a second quick-release drill bit into the driver and drill the anterior-inferior hole. Remove the driver from the joint while leaving the drill bit in place to function as a second anti-rotation peg. Using a third drill bit, drill the remaining posterior-inferior hole (Figure 35).

Remove the guide and alignment pins/drill bits from the joint by backing the guide and drill bits out over the Steinman pin. Remove the Steinman pin from within the joint by using the drill on reverse.

ⓘ **Note:** The standard peripheral peg drill and anti-rotation pegs can be used in place of the quick-connect drill bits if needed.

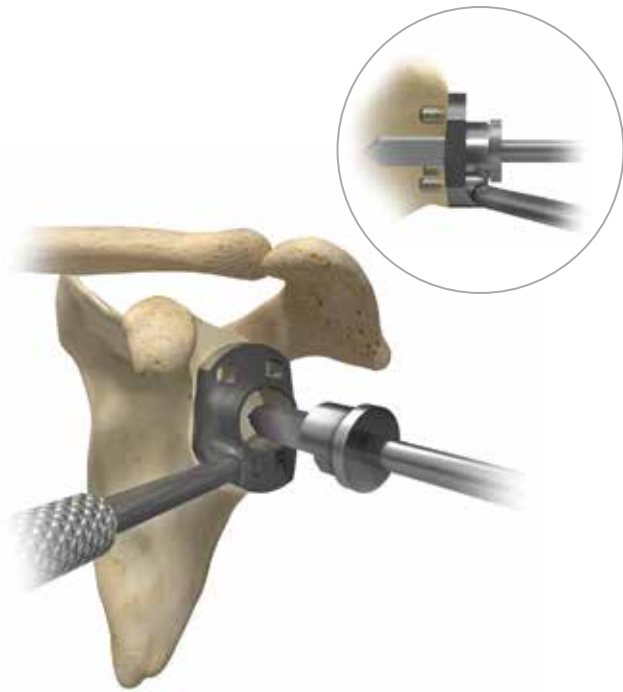

Figure 36

### Optional Poly Post Preparation

If a polyethylene central post is preferred, select the correct size central post cutter guide and insert into the three prepared peripheral holes. Once the guide is fully seated against the face of the glenoid, insert the Poly Post Cutter through the guide and continue to ream until the reamer is fully seated within the guide (Figure 36). Remove the Poly Post Cutter and guide.

**Note:** This step removes additional bone beyond what was previously prepared for the Regenerex Central Post.

Proceed to page 27 for Trial Reduction, Glenoid Insertion and cementing technique



## Non-cannulated Glenoid Technique

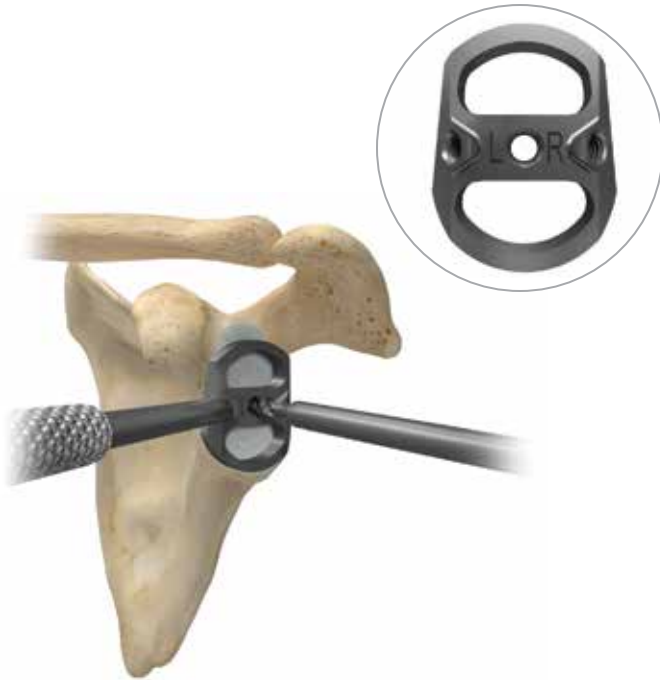

Figure 37

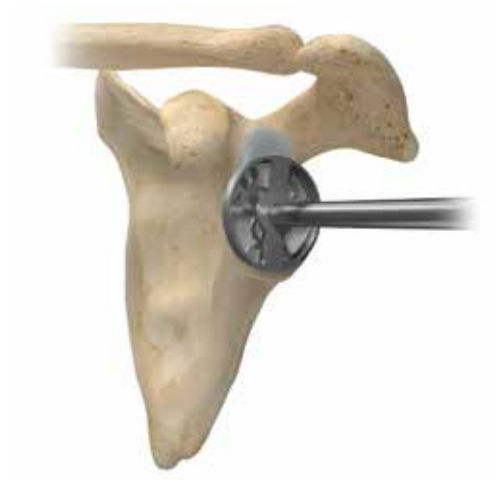

Figure 38

### Sizing and Reaming

Based on the operative shoulder, attach the threaded guide handle to the appropriate anatomic glenoid sizer. Place the sizer in the center of the glenoid with the wide side inferior and firmly seated against the face of the glenoid to give the appropriate position for the centering hole to be drilled.

Drill the hole for the centering peg until the stop is engaged (Figure 37). For both the central pilot hole and subsequent peripheral holes, angled drill bits and instruments are available for tighter/challenging exposure.

Attach the appropriate size glenoid reamer to the desired/chosen reamer shaft. Position the reamer's center peg in the center hole on the glenoid. Ream the face of the glenoid until concentric reshaping is achieved (Figure 38). When finished, the glenoid face should be congruent with the medial side of the glenoid trial and implant. In cases of excessive glenoid wear, ream eccentrically to neutralize the glenoid and prevent instability.

⚠ **Caution:** As with any reaming, it is important that the reamer is rotating prior to coming into contact with bone to avoid any undesirable outcomes.

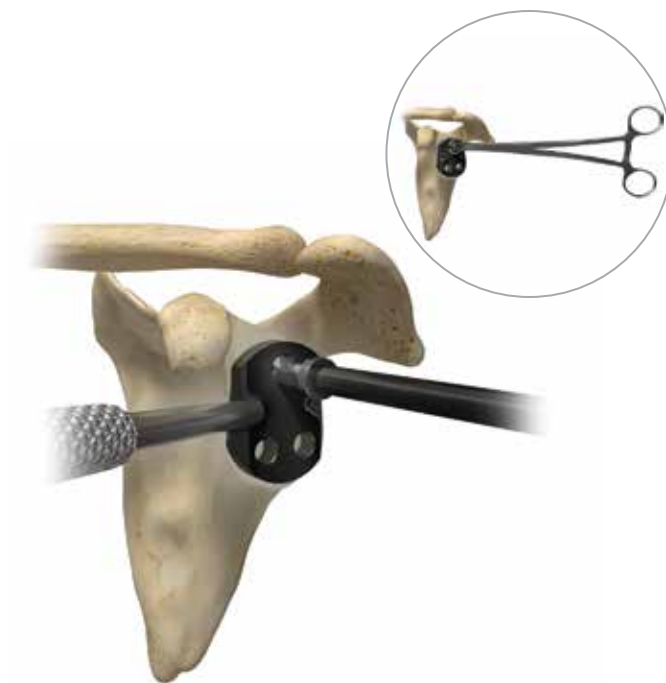

Figure 39

## Peripheral Peg Drilling

Choose the appropriate anatomic drill guide and attach to the threaded guide handle. Place the centering peg in the center hole drilled in the prior step. Ensure the pegged glenoid drill guide is firmly seated on the face of the glenoid. Drill the superior hole until the stop is engaged (Figure 39).

Use the alignment pin forceps to place an alignment pin through the guide and into the superior hole. Move to the anterior-inferior hole and drill until the stop is engaged. Place an additional alignment pin in this hole following drilling with two anti-rotation pegs in place, the peripheral drill guide will not rotate and the posterior-inferior hole can be drilled. Move to the posterior-inferior hole and drill until the stop is engaged, thereby creating the three peripheral peg holes.

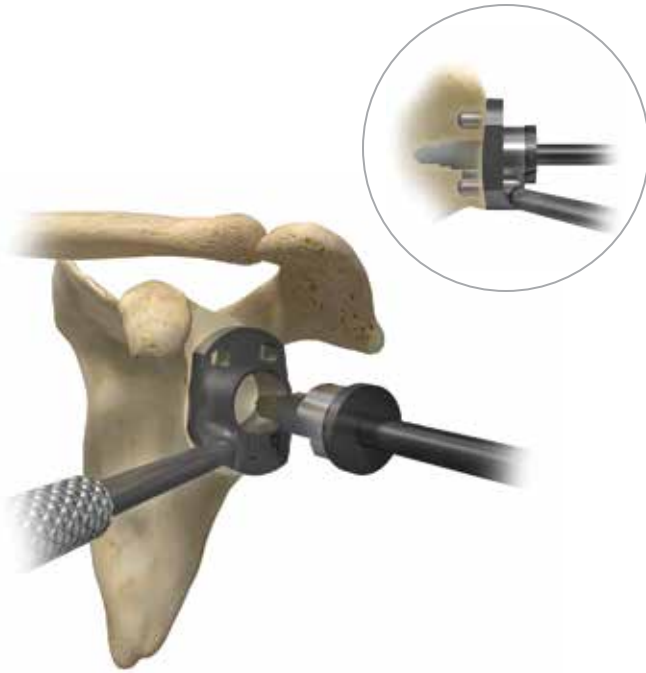

Figure 40



Figure 41

## Regenerex Porous Titanium or Polyethylene Central Peg

Regardless of whether a central peg will be utilized, attach the threaded handle to the center peg drill guide. Firmly seat the alignment pegs on the medial side of the boss cutting guide in the outer peg holes just created. Use the boss cutter and drill until the stop is engaged (Figure 40).

Using the threaded handle attached to the center peg drill guide, place the guide on the face of the glenoid. Firmly seat the drill guide with the three pegs inserted into the outer holes. Based on the chosen central peg, use the appropriate post cutter (Figure 42–Regenerex post cutter shown). Drill until the stop is engaged (Figure 40 inset).

## Trial Reduction

Seat the appropriate size glenoid trial firmly on the face of the glenoid (Figure 41). Ensure the trial is congruent with the reamed surface.

Reassemble the humeral head trial on the humeral broach/trial and evaluate range of motion. Make any necessary adjustments to the humeral head height and diameter to properly tension the joint.



Figure 42



Figure 43A

Figure 43B



Figure 44

## Glenoid Fixation

Remove the glenoid trial. Using a high-speed irrigation lavage system, cleanse the prepared surface. If used, thread the appropriate central peg into the modular hybrid glenoid with the central post driver (Figure 42). Digitally pressurize Colbalt bone cement into the three peripheral holes.

Based on the chosen central peg, use cement as follows: if using the polyethylene central peg, place a small amount of bone cement between the fins and the base of the central peg; if using the Regenerex Porous Titanium central peg, bone cement should not be used on the central post.

Place a thin layer of cement on the medial side of the glenoid component (Figure 43A–Regenerex Porous Titanium central peg; Figure 43B–polyethylene central peg). Insert the glenoid and carefully remove any excess cement (Figure 44).

## Keeled Glenoid Technique

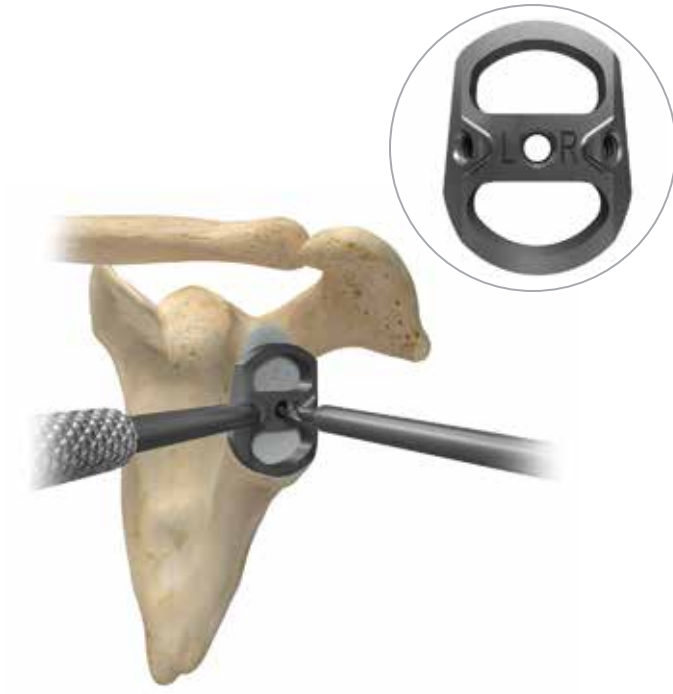

Figure 45



Figure 46

## Sizing and Reaming

Based on the operative shoulder, attach the threaded guide handle to the appropriate anatomic glenoid sizer. Place the sizer in the center of the glenoid with the wide side inferior and firmly seated against the face of the glenoid to give the appropriate position for the centering hole to be drilled. Drill the hole for the centering peg until the stop is engaged (Figure 45).

Attach the appropriate size glenoid reamer to the angled or straight reamer shaft. Position the reamer's center peg in the center hole on the glenoid. Ream the face of the glenoid until concentric reshaping is achieved (Figure 46). When finished, the glenoid face should be congruent with the medial side of the glenoid trial and implant. In cases of excessive glenoid wear, ream eccentrically to neutralize the glenoid and prevent instability.



Figure 47



Figure 48

## Drilling

Attach the threaded guide handle to the keeled glenoid drill guide. Ensuring that the center peg is in the 4 mm center hole and the wide side is inferior, place the drill guide firmly against the glenoid.

Using the 4 mm drill bit, drill holes angling toward the center of the guide in each of the two slots (Figure 47).

Remove the guide and connect the angled holes with a high speed burr. Use the glenoid broach to complete the keel slot (Figure 48). Insert the appropriate size keeled glenoid trial. Reassemble the humeral head trial on the humeral broach/trial and evaluate range of motion. Make any necessary adjustments to the humeral head height or glenoid thickness to properly tension the joint.



Figure 49

## Glenoid Fixation

Remove the glenoid trial. Using a high-speed irrigation lavage system, cleanse the prepared surface. Introduce the appropriately sized component into bone cement with digital pressure to ensure proper component fixation. The glenoid impactor should be used to seat the component (Figure 49). Carefully remove any excess cement, particularly posterior to the component where visualization may be impaired.

## Postoperative Care

Evaluate the limits of external rotation at the time of the subscapularis tendon repair to determine the maximum amount of external rotation during the rehabilitation period. Immobilize the patient in a sling and swathe for 24 hours; use the sling intermittently for up to three weeks to protect the subscapularis repair. Encourage early active motion of the hand and elbow. Begin gentle passive range of motion two days postoperatively. Initiate active assisted elevation three to four days after surgery, based on surgeon preference. Begin strengthening exercises two to three months postoperatively. Continue therapy for many months; patients may show improvement in range of motion and function for up to one year.

## Hybrid Glenoid Removal



Figure 50

Figure 51

Figure 52

### Polyethylene Preparation

After gaining access to the implanted glenoid, section off the three peripheral pegs by making three cuts in a triangular fashion around the central peg using an oscillating saw (Figure 50, 51, and 52).

This will allow the removal of the outer portion of the polyethylene glenoid independently from the central portion.





Figure 53



Figure 54



Figure 55

## Polyethylene Removal

Using a thin osteotome or rongeur, remove the outer portion of the polyethylene glenoid, including the cemented peripheral pegs (Figure 53)

The central portion of the polyethylene can then be unthreaded from the well-fixed polyethylene or Regenerex central post (Figure 54 and 55).

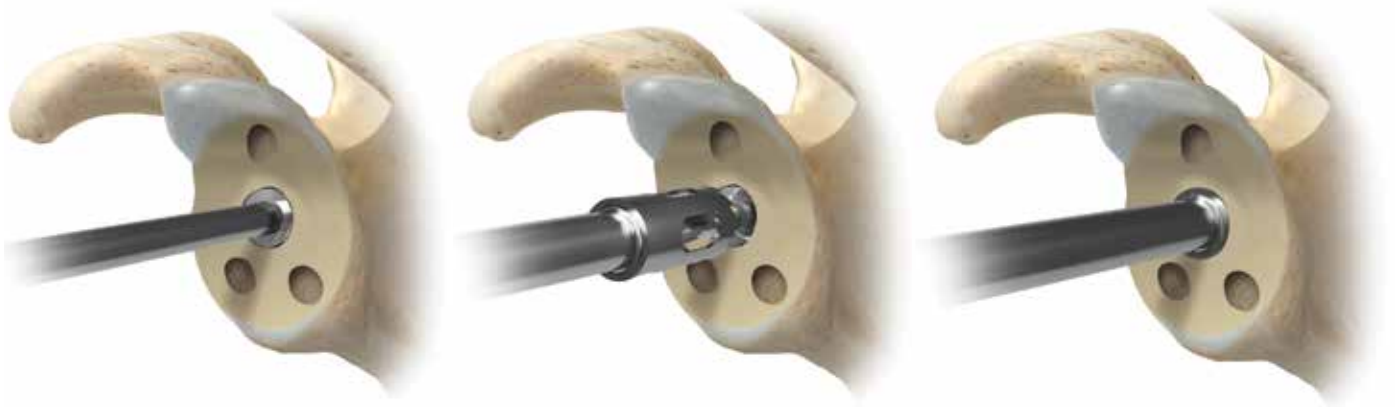

Figure 56

Figure 57

Figure 58

### Central Post Removal

Thread the guide rod onto the central post (Figure 56). Using the guide rod as a cannula, proceed to cut down over the central post using the trephine (Figure 57).

Once the trephine has bottomed out on the central post, remove the trephine from the joint. The guide rod can now be used to remove the central post (Figure 58).

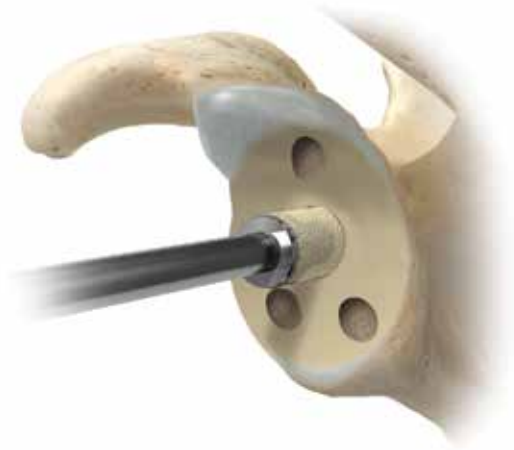

Figure 59



Figure 60

## Central Post Removal

⊖ **Note:** This technique and instrumentation can be used with either previously implanted Polyethylene or Regenerex central post (Figure 59).

⊖ **Note:** The outside diameter of the trephine is smaller than the outside diameter of the Comprehensive Reverse Baseplate central boss. This will leave enough glenoid bone for the Comprehensive Reverse Baseplate Reamer to achieve cancellous reaming (Figure 60).

⊖ **Note:** When considering which reverse baseplate to use on a revision, consider that there will be more interference fit on the standard baseplate as compared to the mini baseplate. This is due to the dimension of the boss being larger on the standard baseplate.



## Appendix–Humeral Stem Sizing

### Mini Stem

Last Reamer Used	Broach To Size	Implant Size
20 STD / 19 MI*	20 mm	20 mm
20 STD / 19 MI	19 mm	19 mm
19 STD / 18 MI	18 mm	18 mm
18 STD / 17 MI	17 mm	17 mm
17 STD / 16 MI	16 mm	16 mm
16 STD / 15 MI	15 mm	15 mm
15 STD / 14 MI	14 mm	14 mm
14 STD / 13 MI	13 mm	13 mm
13 STD / 12 MI	12 mm	12 mm
12 STD / 11 MI	11 mm	11 mm
11 STD / 10 MI	10 mm	10 mm
10 STD / 9 MI	9 mm	9 mm
9 STD / 8 MI	8 mm	8 mm
8 STD / 7 MI	7 mm	7 mm
7 STD / 6 MI	6 mm	6 mm
6 STD / 5 MI	5 mm	5 mm
5 STD / 4 MI**	5 mm	5 mm
4 STD**	4 mm	4 mm



### Standard Stem

Last Reamer Used	Broach To Size	Implant Size
20 STD / 19 MI	20 mm	20 mm
19 STD / 18 MI	19 mm	19 mm
18 STD / 17 MI	18 mm	18 mm
17 STD / 16 MI	17 mm	17 mm
16 STD / 15 MI	16 mm	16 mm
15 STD / 14 MI	15 mm	15 mm
14 STD / 13 MI	14 mm	14 mm
13 STD / 12 MI	13 mm	13 mm
12 STD / 11 MI	12 mm	12 mm
11 STD / 10 MI	11 mm	11 mm
10 STD / 9 MI	10 mm	10 mm
9 STD / 8 MI	9 mm	9 mm
8 STD / 7 MI	8 mm	8 mm
7 STD / 6 MI	7 mm	7 mm
6 STD / 5 MI	6 mm	6 mm
5 STD / 4 MI**	5 mm	5 mm
4 STD**	4 mm	4 mm



\*Ream to horizontal hashmark in order to implant the 20 mm mini stem, as there is not a larger reamer to facilitate reaming to a point between the 3 and 4 hashmark.

\*\*Since there are no numeric hashmarks on the teeth of these reamers, ream to the horizontal hashmark.

## Implants and Trials

Product	Description	Size	Broach/Trial Part Number	Part Number
	Comprehensive Humeral Stem Standard 122 mm	4 mm	407304	113644
		5 mm	407305	113645
		6 mm	407306	113646
		7 mm	407307	113647
		8 mm	407308	113648
		9 mm	407309	113649
		10 mm	407310	113650
		11 mm	407311	113651
		12 mm	407312	113652
		13 mm	407313	113653
		14 mm	407314	113654
		15 mm	407315	113655
		16 mm	407316	113656
		17 mm	407317	113657
		18 mm	407318	113658
		19 mm	407319	113659
		20 mm	407320	113660
	Comprehensive Humeral Stem Mini 83 mm	4 mm	407304	113624
		5 mm	407305	113625
		6 mm	407306	113626
		7 mm	407307	113627
		8 mm	407308	113628
		9 mm	407309	113629
		10 mm	407310	113630
		11 mm	407311	113631
		12 mm	407312	113632
		13 mm	407313	113633
		14 mm	407314	113634
		15 mm	407315	113635
		16 mm	407316	113636
		17 mm	407317	113637
		18 mm	407318	113638
		19 mm	407319	113639
		20 mm	407320	113640

## Implants and Trials (cont.)





Product	Description	Size	Broach/Trial Part Number	Part Number
	<b>Comprehensive Humeral Stem— Micro 55 mm</b>	4 mm	405304	113604
		5 mm	405305	113605
		6 mm	405306	113606
		7 mm	405307	113607
		8 mm	405308	113608
		9 mm	405309	113609
		10 mm	405310	113610
		11 mm	405311	113611
		12 mm	405312	113612
		13 mm	405313	113613
		14 mm	405314	113614
		15 mm	405315	113615
		16 mm	405316	113616
		17 mm	405317	113617
		18 mm	405318	113618
		19 mm	405319	113619
20 mm	405320	113620		
	<b>Comprehensive Humeral Stem— Revision 194 mm</b>	4 mm	407344	113664
		6 mm	407346	113666
		8 mm	407348	113668
		10 mm	407350	113670
		12 mm	407352	113672
		14 mm	407354	113674

## Implants and Trials (cont.)

Product	Description	Size	Trial Part Number	Implant Part Number
	<b>Versa-Dial Humeral Head</b>	38 x 19 x 39 mm	407222	113022
		38 x 21 x 38 mm	407224	113024
		42 x 18 x 46 mm	407232	113032
		42 x 21 x 43 mm	407234	113034
		42 x 24 x 42 mm	407236	113036
		46 x 18 x 53 mm	407242	113042
		46 x 21 x 50 mm	407244	113044
		46 x 24 x 47 mm	407246	113046
		46 x 27 x 46 mm	407248	113048
		50 x 21 x 57 mm	407254	113053
		50 x 24 x 52 mm	407256	113055
		50 x 27 x 50 mm	407258	113057
		54 x 21 x 64 mm	407264	113063
		54 x 24 x 58 mm	407266	113065
		54 x 27 x 55 mm	407268	113067
		58 x 24 x 64 mm	407276	113075
58 x 27 x 61 mm	407278	113077		
	<b>Versa-Dial Titanium Humeral Head</b>	38 x 19 x 39 mm	407222	TI-113022
		38 x 21 x 38 mm	407224	TI-113024
		42 x 18 x 46 mm	407232	TI-113032
		42 x 21 x 43 mm	407234	TI-113034
		42 x 24 x 42 mm	407236	TI-113036
		46 x 18 x 53 mm	407242	TI-113042
		46 x 21 x 50 mm	407244	TI-113044
		46 x 24 x 47 mm	407246	TI-113046
		46 x 27 x 46 mm	407248	TI-113048
		50 x 21 x 57 mm	407254	TI-113053
		50 x 24 x 52 mm	407256	TI-113055
		50 x 27 x 50 mm	407258	TI-113057
		54 x 21 x 64 mm	407264	TI-113063*
		54 x 24 x 58 mm	407266	TI-113065
		54 x 27 x 55 mm	407268	TI-113067
		58 x 24 x 64 mm	407276	TI-113075*
58 x 27 x 61 mm	407278	TI-113077*		
	<b>Comprehensive Standard Taper Adaptor</b>	—	407201	118001







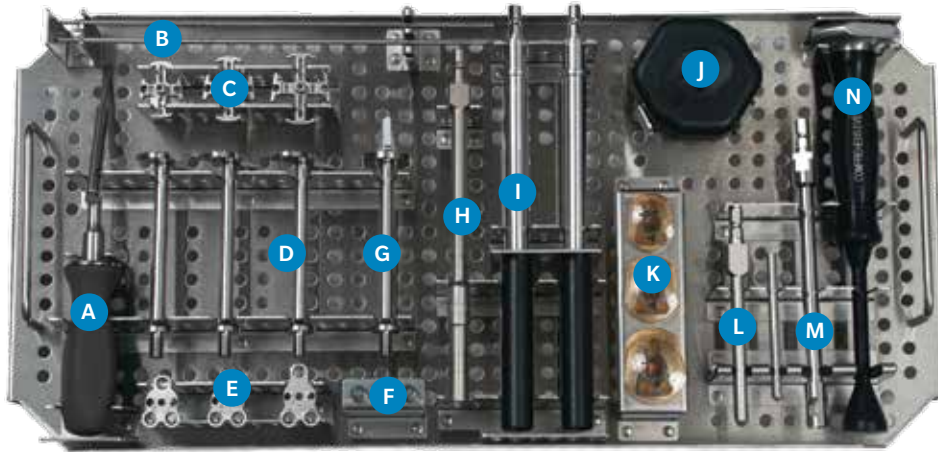

## Implants and Trials (cont.)

Product	Description	Size	Trial Part Number	Implant Part Number
	Modular Hybrid Glenoid Base	SM	—	113952
		MD	—	113954
		LG	—	113956
	Modular Hybrid Glenoid Post— Regenerex	—	—	PT-113950
	Modular Hybrid Glenoid Post— Polyethylene	—	—	113951
	Keeled Glenoid 4 mm	SM	406574	113849
		MD	406575	113851
		LG	406576	113853
	Keeled Glenoid 7 mm	SM	406577	113850
		MD	406578	113852
		LG	406579	113854

Product	Description	Part Number
—	Comprehensive Humeral Primary Stem X-ray Template	TMP407394
—	Versa-Dial Humeral Head X-ray Template	TMP407294
—	Comprehensive Hybrid Glenoid X-ray Template	TMP406199







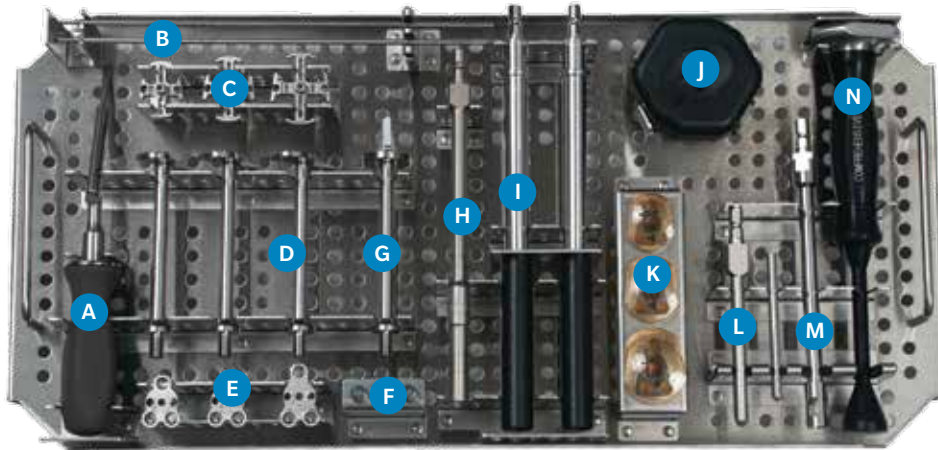

## Comprehensive Access Instrumentation, Top Tray

Product	Description	Label	Size	Part Number
—	Comprehensive Access Glenoid Instrument Case Only	—	—	110003488
—	Comprehensive Access Glenoid Instrument Case Kitted	—	—	110003489
	Access Quick-connect Guide Handle	A	—	110004319
	Access Threaded Steinmann Pin (2)	B	3.2 mm	110003484
	Access Cannulated Glenoid Sizer	C	SM MD LG	010001790 010001791 010001792
	Access Cannulated Glenoid Reamer	D	SM MD LG	110003472 110003474 110003476
	Access Peripheral Drill Guide	E	SM MD LG	010001799 010001800 010001801
	Quick-Release Peripheral Drill/ Anti-rotation Peg	F	—	110003481
	Access 2-N-1 Regenerex Post/ Boss Cutter	G	—	110003478







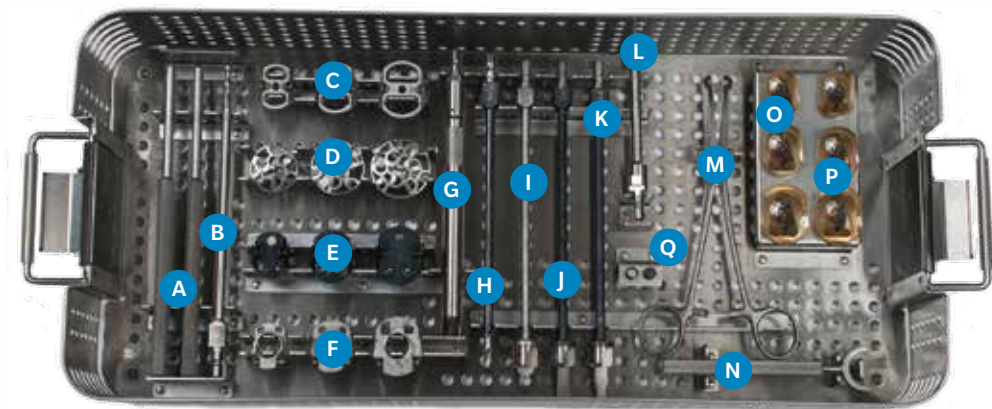

### Comprehensive Access Instrumentation, Top Tray (cont.)

Product	Description	Label	Size	Part Number
	Access Quick-Release Peripheral Drill Shaft	H	—	110003483
	Cannulated Glenoid Reamer Shaft (2)	I	—	110004200
	Access Reamer Disassembly Puck	J	—	110004265
	Modular Hybrid Glenoid Base and Regenerex Glenoid Trial	K	SM MD LG	406192 406193 406194
	Hybrid Glenoid Central Post Driver	L	—	406183
	Hybrid Glenoid Removal Trephine and Rod	M	—	110003486
	Hybrid Glenoid Impactor	N	—	406156







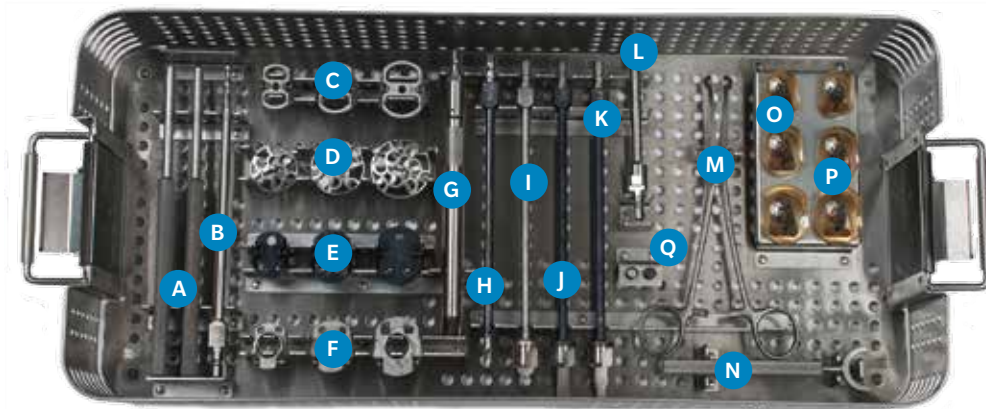





## Comprehensive Access Instrumentation, Bottom Tray

Product	Description	Label	Size	Part Number
—	Comprehensive Access Glenoid Instrument Case Only	—	—	110003488
—	Comprehensive Access Glenoid Instrument Case Kitted	—	—	110003489
	Glenoid Guide Handle	A	—	406849
	Hybrid Glenoid Straight Shank Drill	B	4 mm	406181
	Glenoid Sizer	C	SM MD LG	406831 406832 406833
	Glenoid Reamer	D	SM MD LG	406632 406633 406634
	Peripheral Drill Guide	E	SM MD LG	406160 406162 406164
	Hybrid Glenoid Central Peg Drill Guide	F	SM MD LG	406161 406163 406165
	Reamer Shaft Angled	G	—	RD481137



### Comprehensive Access Instrumentation, Bottom Tray (cont.)

Product	Description	Label	Size	Part Number
	Hybrid Glenoid Straight Shank Peripheral Drill	H	15/64 in	406182
	Hybrid Glenoid Boss Cutter	I	—	406150
	Hybrid Glenoid Polyethylene Post Cutter (PC)	J	—	406152
	Hybrid Glenoid Regenerex Post Cutter (PT)	K	—	406151
	Straight Glenoid Reamer Shaft	L	—	402648
	Peripheral Peg Forceps	M	—	424417
	Glenoid Reamer Wrench	N	—	406525
	Modular Hybrid Glenoid Base Trial	O	SM MD LG	406112 406113 406114
	Modular Hybrid Glenoid Base & Polyethylene Post Trial	P	SM MD LG	406172 406173 406174
	Hybrid Glenoid Drill Guide Alignment Pin	Q	—	406180

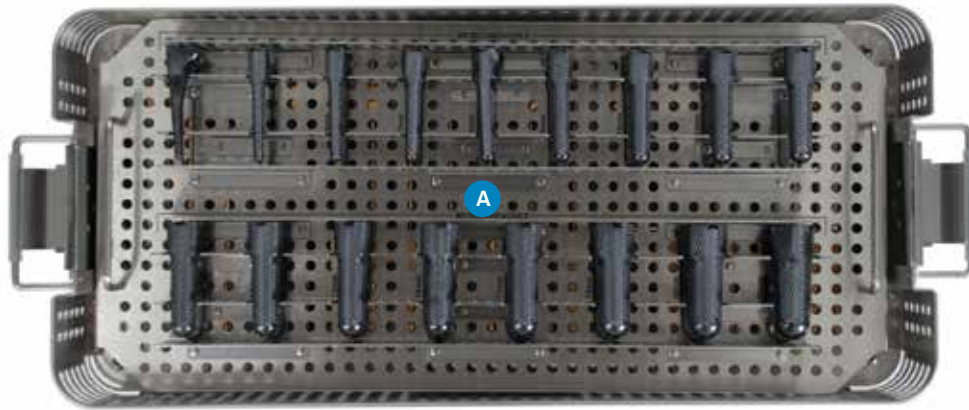

### Comprehensive Micro Instrumentation, Top Tray

Product	Description	Label	Size	Part Number
—	Comprehensive Micro Stem Instrument Case Only	—	—	593693
—	Comprehensive Micro Stem Instrument Case Kitted	—	—	593694
	Comprehensive Micro Broach/Trial	A	4 mm	405304
			5 mm	405305
			6 mm	405306
			7 mm	405307
			8 mm	405308
			9 mm	405309
			10 mm	405310
			11 mm	405311
			12 mm	405312
			13 mm	405313
			14 mm	405314
			15 mm	405315
			16 mm	405316
17 mm	405317			
18 mm	405318			
19 mm	405319			
	20 mm	405320		

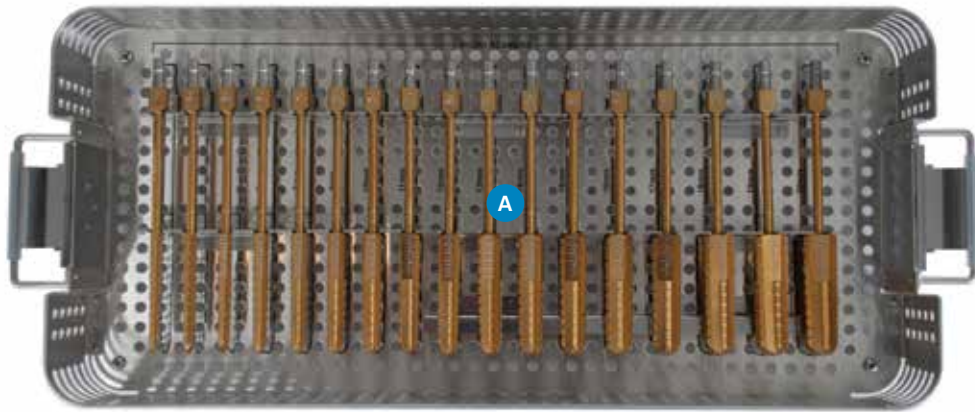



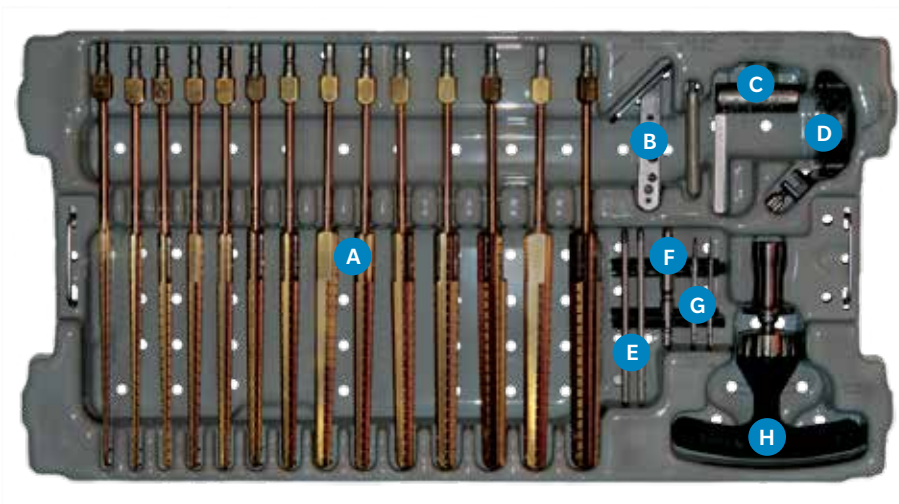

Comprehensive Micro Instrumentation, Bottom Tray

Product	Description	Label	Size	Part Number
—	Comprehensive Micro Stem Instrument Case Only	—	—	593693
—	Comprehensive Micro Stem Instrument Case Kitted	—	—	593694
	Comprehensive Micro Humeral Reamer	A	4 mm	41-405804
			5 mm	41-405805
			6 mm	41-405806
			7 mm	41-405807
			8 mm	41-405808
			9 mm	41-405809
			10 mm	41-405810
			11 mm	41-405811
			12 mm	41-405812
			13 mm	41-405813
			14 mm	41-405814
			15 mm	41-405815
			16 mm	41-405816
17 mm	41-405817			
18 mm	41-405818			
19 mm	41-405819			
	20 mm	41-405820		







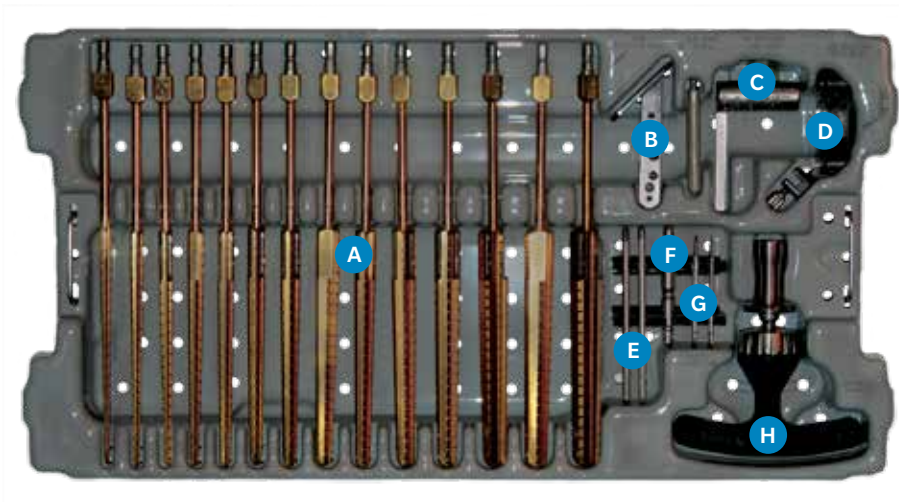

### Comprehensive Humeral Reamer Instrumentation

Product	Description	Label	Size	Part Number
—	Comprehensive Primary Reamer Instrument Case	—	—	595258
	Comprehensive Humeral Reamer	A	4 mm	41-406804
			5 mm	41-406805
			6 mm	41-406806
			7 mm	41-406807
			8 mm	41-406808
			9 mm	41-406809
			10 mm	41-406810
			11 mm	41-406811
			12 mm	41-406812
			13 mm	41-406813
			14 mm	41-406814
			15 mm	41-406815
			16 mm	41-406816
17 mm	41-406817			
18 mm	41-406818			
19 mm	41-406819			
20 mm	41-406820			
	Comprehensive Extramedullary Resection Guide with Version Rod	B	—	407392
	Comprehensive Intramedullary Resection Guide Boom with Version Rod	C	—	407397
	Comprehensive Intramedullary Resection Guide Block	D	—	407396







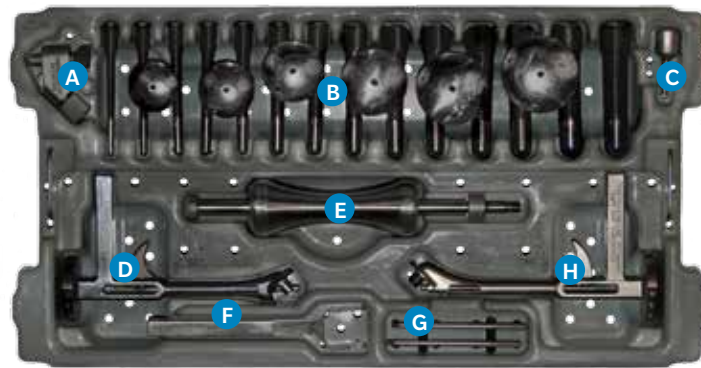

Comprehensive Humeral Reamer Instrumentation (cont.)

Product	Description	Label	Size	Part Number
	Comprehensive Screw- in Version Rod	E	—	407395
	Pin Driver	F	—	32-486259
	Threaded Steinmann Pins	G	1/8 x 2.5 in	406669
	Ratcheting T-handle	H	—	406801



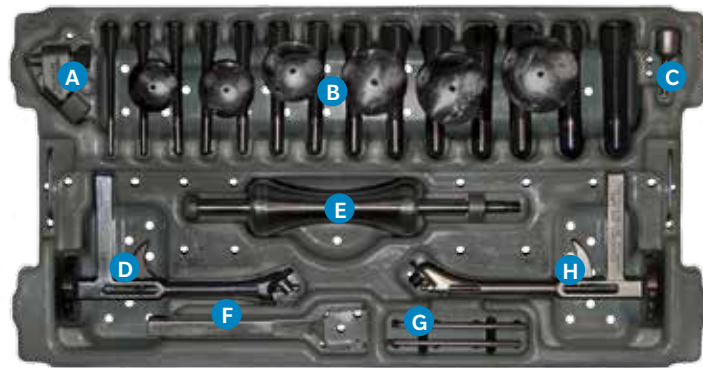

### Comprehensive Primary Broach Instrumentation

Product	Description	Label	Size	Part Number
—	Comprehensive Primary Broach Instrument Case	—	—	595257
	Comprehensive Stem Extractor	A	—	406997
	Comprehensive Mini Broach/Trial	B	4 mm 5 mm 6 mm 7 mm 8 mm 9 mm 10 mm 11 mm 12 mm 13 mm 14 mm 15 mm 16 mm 17 mm	407304 407305 407306 407307 407308 407309 407310 407311 407312 407313 407314 407315 407316 407317
	Comprehensive Broach Extractor Tool	C	—	407393
	Comprehensive Broach Handle with Version Rod	D	—	407399
	Slide Hammer	E	—	31-473621







Comprehensive Primary Broach Instrumentation (cont.)

Product	Description	Label	Size	Part Number
	Versa-Dial Head Removal Tool	F	—	407389
	Screw-in Version Rod	G	—	407395
	Comprehensive Stem Inserter with Version Rod	H	—	407398







## Comprehensive Humeral Head Instrumentation

Product	Description	Label	Size	Part Number
—	Comprehensive Primary Versa-Dial Humeral Head Instrument Case	—	—	595259
	Versa-Dial Taper Extractor	A	—	407298
	Versa-Dial Humeral Head Trial	B	38 x 19 x 39 mm 38 x 21 x 38 mm 42 x 18 x 46 mm 42 x 21 x 43 mm 42 x 24 x 42 mm 46 x 18 x 53 mm 46 x 21 x 50 mm 46 x 24 x 47 mm 46 x 27 x 46 mm 50 x 21 x 57 mm 50 x 24 x 52 mm 50 x 27 x 50 mm 54 x 21 x 64 mm 54 x 24 x 58 mm 54 x 27 x 55 mm 58 x 24 x 64 mm 58 x 27 x 61 mm	407222 407224 407232 407234 407236 407242 407244 407256 407248 407254 407256 407258 407264 407266 407268 407276 407278
	Calcar Planer with Six Blades	C	—	406660
	Versa-Dial Trial Head Screw Drive	D	—	407296







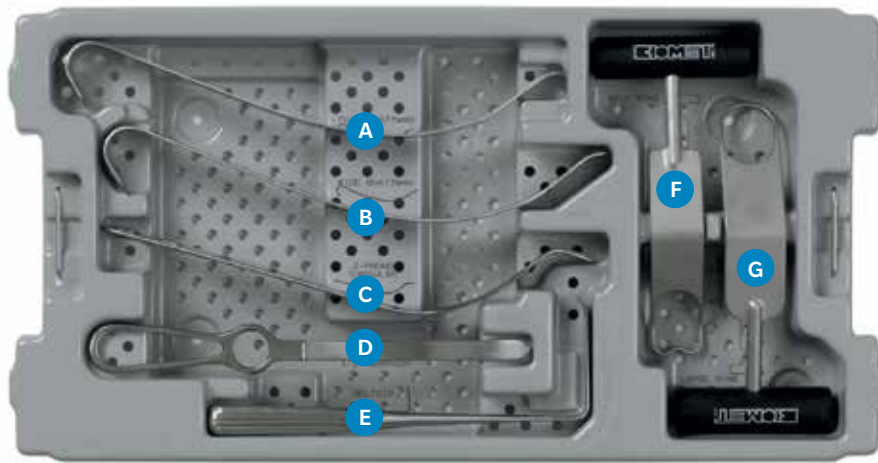

Comprehensive Humeral Head Instrumentation (cont.)



Product	Description	Label	Size	Part Number
	Versa-Dial Head Impactor	E	—	407297
	Comprehensive Standard Trial Taper Adapters	F	—	407201
	Versa-Dial Taper Impactor Base	G	—	407281
	Versa-Dial Taper Impactor	H	—	407280
—	Versa-Dial Head Sizer Plate	I	—	407293



### 595505 Comprehensive Retractor Set Total Instrument Case

Product	Description	Label	Part Number
	Thin Glenoid Retractor	A	405892
	Wide Glenoid Retractor	B	405893
	2-Prong Capsular Retractor	C	402852
	Modified Darrach Retractor	D	405895
	Golf Club Retractor	E	405891
	Bent Ring Fukuda	F	994500850
	Large Ring Fukuda	G	406699

## Comprehensive Keeled Instrumentation

Product	Description	Size	Part Number
	Keeled Glenoid Instrument Case	—	595265
	Keeled Glenoid Drill Guide	SM	406837
		MD	406838
		LG	406839
	Keeled Broach	—	406587

## Instrumentation Not Included within Standard Set

Product	Description	Size	Part Number
	Angel Wing/Tissue Probe	—	994500111
	Comprehensive Broach Protector Plate Set	—	407391
	Propeller Glenoid Reamer - Long Nipple	SM	010001787
		MD	010001788
		LG	010001789
	Glenoid Reamer-Long Nipple	SM	406897
		MD	406898
		LG	406899
	Straight Glenoid Reamer Shaft Long	8 in	406896
	Glenoid Vault Pin Guide	—	110004203

All trademarks herein are the property of Biomet, Inc. or its subsidiaries unless otherwise indicated.

This material is intended for the sole use and benefit of the Biomet sales force and physicians. It is not to be redistributed, duplicated or disclosed without the express written consent of Biomet.

For product information, including indications, contraindications, warnings, precautions and potential adverse effects, see the package insert and the Patient Risk Information at [www.Biomet.com](http://www.Biomet.com).

This material is intended for health care professionals and the Biomet sales force only. Distribution to any other recipient is prohibited. All content herein is protected by copyright, trademarks and other intellectual property rights owned by or licensed to Biomet Inc. or its affiliates unless otherwise indicated. This material must not be redistributed, duplicated or disclosed, in whole or in part, without the express written consent of Biomet.

Check for country product clearances and reference product specific instructions for use. For complete product information, including indications, contraindications, warnings, precautions, and potential adverse effects, see the package insert and Biomet's website.

This technique was prepared in conjunction with a licensed health care professional. Biomet does not practice medicine and does not recommend any particular orthopedic implant or surgical technique for use on a specific patient. The surgeon is responsible for determining the appropriate device(s) and technique(s) for each individual patient.

Not for distribution in France.

©2016 Zimmer Biomet



**Authorized Representative**

Biomet UK Ltd.  
Waterton Industrial Estate  
Bridgend, South Wales  
CF31 3XA  
UK



**Legal Manufacturer**

Biomet Orthopedics  
P.O. Box 587  
56 E. Bell Drive  
Warsaw, Indiana 46581-0587  
USA

[www.zimmerbiomet.com](http://www.zimmerbiomet.com)



**ZIMMER BIOMET**

Your progress. Our promise.™

Form No. BMET0206.3 • REV0516

**CE 0086**

CE mark on a surgical technique is not valid unless there is a CE mark on the product label.